

WATTNODE[®] BACNET[®]

Electric Power Meter - Installation Manual

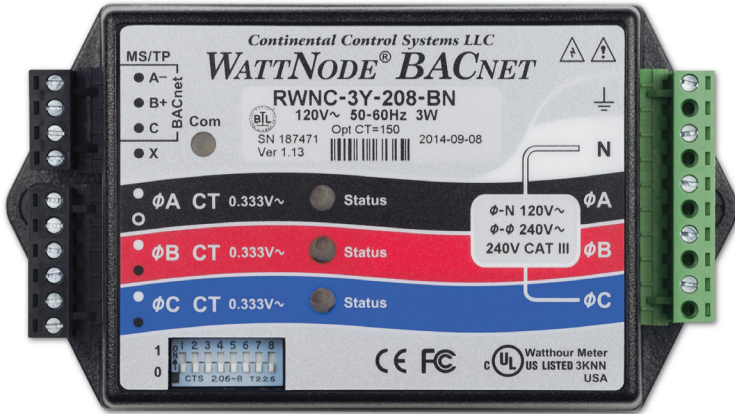

WattNode BACnet Models

WNC-3Y-208-BN
WNC-3Y-400-BN
WNC-3Y-480-BN
WNC-3Y-600-BN
WNC-3D-240-BN
WNC-3D-400-BN
WNC-3D-480-BN

WattNode Revenue for BACnet Models

RWNC-3Y-208-BN
RWNC-3Y-400-BN
RWNC-3Y-480-BN
RWNC-3Y-600-BN
RWNC-3D-240-BN
RWNC-3D-400-BN
RWNC-3D-480-BN



**Continental
Control
Systems, LLC**

www.ctlsys.com

Contents

1	Precautions	3
1.9	Symbols	3
2	Overview	3
2.1	Additional Literature	3
2.2	Electrical Service Types	4
3	Installation	7
3.1	Installation Checklist	7
3.2	Mounting	7
3.3	Connect Voltage Terminals	7
3.4	Connect Current Transformers	8
3.5	Connect the Output Signals	9
3.6	Connect Thermistor	10
4	Operation	10
4.1	Initial Configuration	10
4.2	Power Status LEDs	10
4.3	Communication LED	12
4.4	Monitoring	12
4.5	Maintenance and Repair	12
5	Specifications	12
5.1	Accuracy	12
5.2	Measurement	13
5.3	Electrical	13
5.4	Thermistor Input	14
5.5	EIA RS-485 Interface	14
5.6	Certifications	15
5.7	Environmental	15
5.8	Mechanical	15
5.9	FCC Information	15
5.10	Warranty	16
5.11	Limitation of Liability	16

1 Precautions

- 1.1 Only qualified personnel or **licensed electricians** should install the WattNode meter. The mains voltages of 120 to 600 Vac can be lethal!
- 1.2 Follow all applicable local and national electrical and safety codes.
- 1.3 The terminal block screws are **not** insulated. Do not contact metal tools to the screw terminals if the circuit is live!
- 1.4 Verify that circuit voltages and currents are within the proper range for the meter model.
- 1.5 Use only UL Listed or UL Recognized current transformers (CTs) with built-in burden resistors, that generate 0.333 Vac (333 millivolts AC) at rated current. **Do not use current output (ratio) CTs such as 1 amp or 5 amp output CTs: they will destroy the meter and may create a shock hazard.**
- 1.6 Protect the line voltage conductors to the meter with fuses or circuit breakers (not needed for the neutral or ground wires). See 3.3.1 below.
- 1.7 Equipment must be disconnected from the HAZARDOUS LIVE voltages before access.
- 1.8 If the meter is not installed correctly, the safety protections may be impaired.

1.9 Symbols



Read, understand, and follow all instructions including warnings and precautions before installing and using the product.



Potential Shock Hazard from Dangerous High Voltage.



Functional ground; should be connected to earth ground if possible, but is not required for safety grounding.



UL Listing mark for U.S.A. and Canada.



FCC Mark. This logo indicates compliance with part 15 of the FCC rules.



Complies with the regulations of the European Union for Product Safety and Electro-Magnetic Compatibility.

- Low Voltage Directive – EN 61010-1:2010 (3rd Edition)
- EMC Directive – EN 61326-1:2013



This indicates an AC voltage.

2 Overview

Congratulations on your purchase of the WattNode® BACnet® or WattNode® Revenue for BACnet® watt/watt-hour transducer (meter). It is designed for use in demand side management (DSM), submetering, energy monitoring, billing and renewable energy applications. The WattNode meter communicates on an EIA RS-485 two-wire bus using the BACnet protocol.

The WattNode Revenue (RWNC) version meets the ANSI C12.1 standard for revenue metering when used with IEEE C57.13 class 0.6 current transformers, such as the Accu-CT®.

WattNode BACnet models are BTL (BACnet Testing Laboratories) certified for interoperability.

2.1 Additional Literature

See the Continental Control Systems, LLC website (www.ctlsys.com) for product pages, datasheets, and support pages for all WattNode meter models and current transformers. Each WattNode model has an **Operating and Reference Guide** with detailed information on the available measurements and interface.

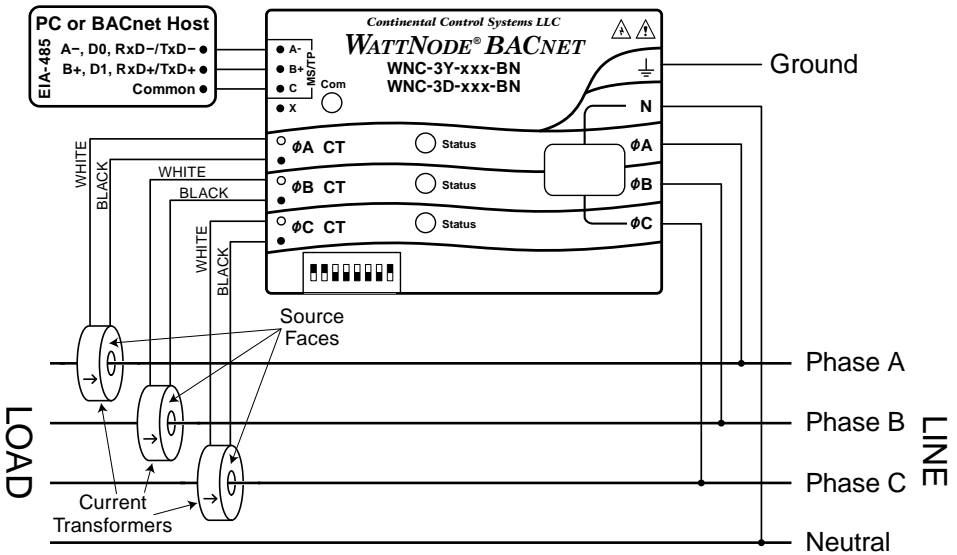

Figure 1: WattNode Wiring Diagram

2.2 Electrical Service Types

Electrical Service (or Load) Types	Line-to-Neutral (Vac)	Line-to-Line (Vac)	Meter Service Type	Meter Powered by
1 Phase 2 Wire 120V with neutral	96 – 138	n.a.	3Y-208	N and ΦA
1 Phase 2 Wire 230V with neutral (non-N.A.)	184 – 264	n.a.	3Y-400	N and ΦA
1 Phase 2 Wire 277V with neutral	222 – 318	n.a.	3Y-480	N and ΦA
1 Phase 2 Wire 208V no neutral	n.a.	166 – 276	3D-240	ΦA and ΦB
1 Phase 2 Wire 240V no neutral	n.a.	166 – 276	3D-240	ΦA and ΦB
1 Phase 3 Wire 120V/240V with neutral	96 – 138	166 – 276	3Y-208	N and ΦA
			3D-240	ΦA and ΦB
3 Phase 3 Wire Delta 208V no neutral	n.a.	166 – 276	3D-240	ΦA and ΦB
3 Phase 3 Wire Delta 400V no neutral (non-N.A.)	n.a.	320 – 460	3D-400	ΦA and ΦB
3 Phase 3 Wire Delta 480V no neutral	n.a.	384 – 552	3D-480	ΦA and ΦB
3 Phase 4 Wire Wye 120V/208V with neutral	96 – 138	166 – 276	3Y-208	N and ΦA
			3D-240	ΦA and ΦB
3 Phase 4 Wire Delta 120/208/240V with neutral	96 – 138	166 – 276	3D-240	ΦA and ΦB
3 Phase 4 Wire Wye 230V/400V with neutral (non-N.A.)	184 – 264	320 – 460	3Y-400	N and ΦA
			3D-400	ΦA and ΦB
3 Phase 4 Wire Wye 277V/480V with neutral	222 – 318	384 – 552	3Y-480	N and ΦA
			3D-480	ΦA and ΦB
3 Phase 4 Wire Delta 240/415/480V with neutral	222 – 318	384 – 552	3D-480	ΦA and ΦB
3 Phase 4 Wire Wye 347V/600V with neutral	278 – 399	480 – 690	3Y-600	N and ΦA

Table 1: WattNode Models

Table 1 above lists the WattNode models and common circuit types. In the “Electrical Service Types” column, when two voltages are listed with a slash between them, they indicate the line-to-neutral / line-to-line voltages. The “Line-to-Neutral” and “Line-to-Line” columns show the operating ranges for the WattNode meters. “non-N.A.” refers to non-North American electrical services.

Connect the line voltages to the meter inputs as shown in the following figures for each service type. See **Figure 1** above for an overview.

2.2.1 Single-Phase Two-Wire with Neutral

This is a common residential and branch circuit connection. Up to three such circuits may be monitored with one meter by also using the ϕB and ϕC inputs.

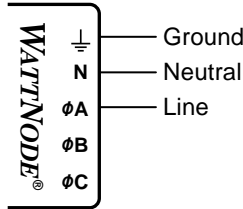

2.2.2 Single-Phase Two-Wire No Neutral

This circuit occurs in residential (commonly 120/240 Vac) and some commercial applications. The meter is powered from the ϕA and ϕB terminals. We recommend connecting the N terminal to ground to provide a clean voltage reference for the measurement circuitry (no current will flow through this terminal).

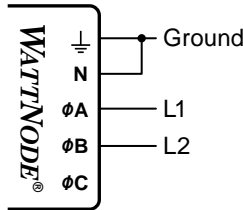

2.2.3 Single-Phase Three-Wire with Neutral

This is a common residential service at 120/240 Vac.

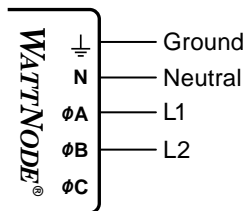

2.2.4 Three-Phase Three-Wire Delta No Neutral

This is common in commercial and industrial settings. In some cases, the service may be four-wire, wye but the load may only be three wire (no neutral).

Occasionally, a load will only be connected to two of the three lines (say L1 and L2). For this case, connect the two active lines to the ϕA and ϕB terminals and connect two CTs for the two lines.

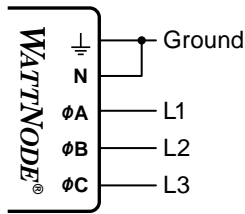

2.2.5 Three-Phase Four-Wire Wye with Neutral

This is a common commercial and industrial service.

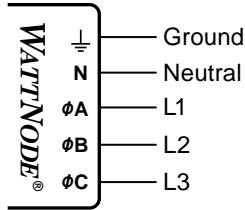

2.2.6 Three-Phase Four-Wire Delta with Neutral (Wild Leg)

The uncommon four-wire delta electrical service is a three-phase delta service with a center-tap on one of the transformer windings to create a neutral for single-phase loads.

The high-leg or phase with the higher voltage as measured to neutral has traditionally been designated “Phase B”. A change to the 2008 NEC now allows the high leg of a four-wire three-phase delta service to be labeled as the “C” phase instead of the “B” phase. The WattNode meter will work correctly with the high-leg connected to ϕA , ϕB , or ϕC .

See the web article https://ctlsys.com/support/four_wire_delta_circuits/ for more information.

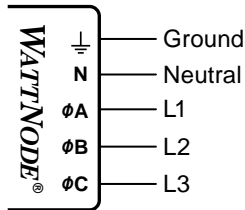

2.2.7 Grounded Leg Service

In rare cases with delta services or single-phase two-wire services without neutral, one of the phases may be grounded.

The WattNode meter will correctly measure services with a grounded leg, but the measured voltage and power for the grounded phase will be zero and the status LEDs will not light for the grounded phase, because the voltage is near zero. Also, this type of service may result in unusual power factors.

For more information, see https://ctlsys.com/support/corner-grounded_delta_circuits/.

3 Installation

3.1 Installation Checklist

See the sections referenced below for installation details.

- Turn off power** before making line voltage connections.
- Mount the WattNode meter (see **3.2**).
- Connect circuit breakers or fuses and disconnects (see **3.3.1**).
- Connect the line voltage wires to the meter's green terminal block (see **3.3.2**).
- Mount the CTs around the line conductors. Make sure the CTs face the **source** (see **3.4**).
- Connect the twisted white and black wires from the CTs to the black terminal block on the meter, matching the wire colors to the white and black dots on the meter label (see **3.4.1**).
- Check that the CT phases match the line voltage phases (see **3.4**).
- Record the CT rated current for each meter, because it will be required during commissioning.
- Connect the output terminals of the WattNode meter to the monitoring equipment (see **3.5**).
- Check that all the wires are securely installed in the terminal blocks by tugging on each wire.
- Turn on power to the meter.
- Verify that the LEDs indicate correct operation (see **4.2, 4.3**).

3.2 Mounting

- Protect the meter from temperatures below -40°C (-40°F) or above 75°C (167°F), excessive moisture, dust, salt spray, or other contamination, using a NEMA rated enclosure if necessary. The meter requires an environment no worse than pollution degree 2 (normally only non-conductive pollution; occasionally, a temporary conductivity caused by condensation).
- The meter must be installed in an electrical service panel or an enclosure.
- **Do not** use the meter as a drilling guide; the drill chuck can damage the screw terminals and metal shavings may fall into the connectors.

The meter has two mounting holes spaced 5.375 in. (137 mm) apart (center-to-center). These mounting holes are normally obscured by the detachable screw terminals. Remove the screw terminals to mark the hole positions and mount the meter.

Self-tapping #8 sheet metal screws are included. Don't over-tighten the screws, as long-term stress on the case can cause cracking.

3.3 Connect Voltage Terminals

3.3.1 Circuit Protection

The WattNode meter is considered "permanently connected equipment" and requires a disconnect means (circuit breaker, switch, or disconnect) and overcurrent protection (fuse or circuit breaker).

The meter only draws 10-30 milliamps, so the rating of any disconnect switch, fuses, and/or circuit breakers is determined by the wire gauge, the mains voltage, and the current interrupting rating required.

- The disconnect or circuit breaker must be clearly marked, suitably located, and easily reached.
- Use circuit breakers or fuses rated for 20 amps or less.
- Use ganged circuit breakers when monitoring more than one line voltage.
- The circuit breakers or fuses must protect the mains terminals labeled ϕA , ϕB , and ϕC . In the rare cases where neutral has overcurrent protection, then the overcurrent protection device must interrupt both neutral and the ungrounded conductors simultaneously.
- The circuit protection / disconnect system must meet IEC 60947-1 and IEC 60947-3, as well as all national and local electrical codes.

3.3.2 Line Wiring

- **Always turn off power** before connecting the line voltage inputs to the meter.
- For the line voltage wires, CCS recommends 16 to 12 AWG stranded wire, type THHN, MTW, or THWN, 600 V.
- Do not place more than one voltage wire in a screw terminal; use separate wire nuts or terminal blocks if needed.
- Verify that the line voltages are in the range of the line-to-line ϕ - ϕ and line-to-neutral ϕ -N values printed in the white box on the front label.

The screw terminals handle wire up to 12 AWG. Connect each voltage line to the green terminal block as shown in **Figure 1** above. After the voltage lines have been connected, make sure both terminal blocks are fully seated in the meter.

Connect each line voltage to the appropriate phase; also connect ground and neutral (if applicable). The neutral connection “N” is not required on delta models (3D-240, 3D-400, and 3D-480), but we recommend connecting it to ground if neutral is not present.

When power is first applied, check that the LEDs behave normally. If you see LEDs flashing red-green-red-green (see **Figure 7**), the line voltage is too high for this model, so disconnect the power immediately!

3.3.3 Grounding

The WattNode uses a plastic enclosure, insulation, and internal isolation barriers instead of protective earthing. The ground terminal on the green screw terminal block is a functional ground, designed to improve the measurement accuracy and noise immunity. If necessary, this terminal may be left disconnected on wye models (-3Y).

3.4 Connect Current Transformers

To meet the UL listing requirements, the WattNode Pulse meter may only be used with UL Listed CTs with a 333 mVac output or the following UL Recognized current transformer models, which all generate 333 millivolts AC at rated current. See the current transformer datasheets for CT ratings.

ACT-0750-xxx	CTS-2000-xxxx	CTT-1000-xxx
CTL-1250-xxx	CTB-WxL-xxxx	CTT-1250-xxx
CTM-0360-xxx	CTT-0300-xxx	CTRC-yyyyy-xxxx
CTS-0750-xxx	CTT-0500-xxx	
CTS-1250-xxx	CTT-0750-xxx	

- “xxx” indicates the full scale current rating.
- “WxL” indicates the opening width (W) and leg length (L) in inches.
- “dddd” indicates the opening diameter of the loop for flexible Rogowski CTs.
- “yyyyy” indicates the opening size in mils (thousandths of inches).

See the web article [Selecting Current Transformers](#) for information on selecting appropriate current transformers (CTs).

- **Do not** use ratio or current output CTs such as 1 amp or 5 amp output models!
- See the CT datasheets for the maximum input current ratings.
- Be careful to match the CTs with the voltage phases. Make sure the ϕ A CT is measuring the current on the same phase as the ϕ A voltage input, and the same for phases B and C. Use the supplied colored labels or colored tape to identify the CT leads.
- To minimize current measurement noise, avoid extending the CT wires, especially in noisy environments. If it is necessary to extend the wires, use twisted pair wire 22 to 14 AWG, rated for 300 V or 600 V (not less than the service voltage) and shielded if possible.
- Find the source arrow or label “THIS SIDE TOWARD SOURCE” on the CT and face/point toward the source of current.
- OPTIONAL: if you see spurious readings on unused phases, jumper the unused CT inputs: for each unused CT, connect a short wire from the terminal marked with a white dot to the terminal marked with a black dot.

Install the CTs around the conductor to be measured and connect the CT leads to the meter. **Always turn off power before disconnecting any live conductors.**

Split-core CTs can be opened for installation around a conductor. A nylon cable tie may be secured around the CT to prevent inadvertent opening. If using solid-core CTs, put the line conductors through the CTs as shown in **Figure 1** above.

CTs are directional. If they are mounted backwards or with their white and black wires swapped the measured power will be negative. The status LEDs indicate negative measured power by flashing red.

When installing WattNode Revenue models, be sure to only use IEEE C57.13 class 0.6 current transformers, such as the Accu-CT; other CTs are less accurate and may not provide revenue accuracy. Contact sales for more information on appropriate CTs.

3.4.1 CT Wiring

The current transformers connect to the six position black screw terminal block. Connect the white and black CT wires to the meter terminals marked **ØA CT**, **ØB CT**, and **ØC CT** (see **Figure 1** above). Excess length may be trimmed from the wires if desired. Connect each CT with the white wire aligned with the white dot on the label, and the black wire aligned with the black dot. Note the order in which the phases are connected, as the line voltage phases **must** match the current phases for accurate power measurement.

3.5 Connect the Output Signals

- The meter outputs are electrically isolated from dangerous voltages.
- If the output wiring is near line voltage wiring, use wires or cables with a 300 V or 600 V rating (not less than the service voltage).
- If the output wiring is near bare conductors, it should be double insulated or jacketed.
- You may install two wires into each screw terminal by twisting the wires together, inserting them into terminal, and securely tightening. Note: a loose wire can disable an entire network section.
- Use shielded twisted-pair cable to prevent interference. If there is no common conductor, connect the shield to the **C** terminal.

3.5.1 BACnet MS/TP

The WattNode BACnet meter can be connected to BACnet monitoring equipment, gateways, and other BACnet devices.

Use DIP switches 1-6 to select the BACnet MAC address (0 to 63).

DIP Switch	1	2	3	4	5	6
Up (1) Value	1	2	4	8	16	32
Address	Examples					
1	1, Up	0, Down	0, Down	0, Down	0, Down	0, Down
1+2+4 = 7	1, Up	1, Up	1, Up	0, Down	0, Down	0, Down
4+16 = 20	0, Down	0, Down	1, Up	0, Down	1, Up	0, Down
1+2+16+32 = 51	1, Up	1, Up	0, Down	0, Down	1, Up	1, Up

Select the baud rate by setting DIP switch positions 7 and 8 as shown below. The change will take effect in approximately ten seconds.

Baud Rate	DIP Switch 7	DIP Switch 8
9,600 (default)	0, Down	0, Down
19,200	1, Up	0, Down
38,400	0, Down	1, Up
76,800	1, Up	1, Up

3.5.2 Connect RS-485

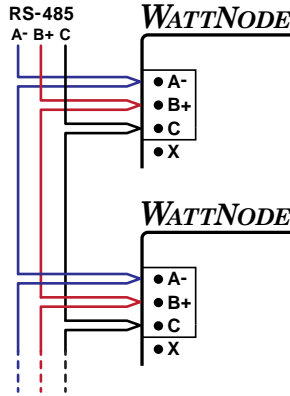

- RS-485 wiring can be complex when multiple devices are connected, when running wires for long distances, and when using termination and biasing resistors. If you have any questions, consult the [Operating and Reference Guide](#).
- Be sure to connect the **A-**, **B+**, and **C** (common) terminals. The **X** terminal is normally not used. You may use the cable shield (if present) for the **C** connection.
- For long distances, use shielded twisted-pair cable to prevent interference. With shielded cable, connect the shield to earth ground at one end.
- RS-485 wiring is daisy-chained between meters, with up to 64 devices per subnet.

3.6 Connect Thermistor

If you ordered your meter with **Option TM1** for use with an external thermistor for temperature monitoring, you may connect the thermistor as shown below. See [5.4 Thermistor Input](#) for details on the required thermistor. Thermistor leads are not polarized, so either lead by by connected to either of the **C** and **X** screw terminals.

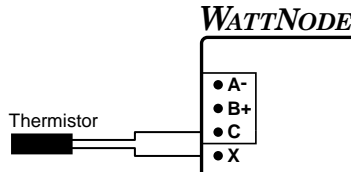

4 Operation

4.1 Initial Configuration

Generally, the network integrator will remotely configure the WattNode meter and the variables. For details on configuring the WattNode meter, see the appropriate [Operating and Reference Guide](#) for your model.

The meter does not include a display or buttons, so it is not possible to configure or monitor the meter directly, other than the basic LED diagnostics described below.

At a minimum, the **CtAmps** must be programmed with the rated amps of the attached current transformers for correct measurements.

4.2 Power Status LEDs

The three status LEDs on the front of the meter can help indicate correct measurements and operation. The “**A**”, “**B**”, and “**C**” on the diagrams indicate the three phases.

4.2.1 Normal Startup

The meter displays the following startup sequence whenever power is first applied.

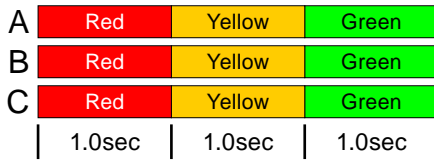

4.2.2 Positive Power

Any phase with the LEDs flashing green is indicating normal positive power.

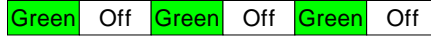

4.2.3 No Power

Any phase with a solid green LED indicates no power, but line voltage is present.



4.2.4 No Voltage

Any phase LED that is off indicates no voltage on that phase.



4.2.5 Negative Power

Red flashing indicates negative power for that phase. Reversed CTs, swapped CT wires, or CTs not matched with line voltage phases can cause this.



4.2.6 Overvoltage Warning

The following indicates that the line voltage is too high for this model. **Disconnect power immediately!** Check the line voltages and the meter ratings (in the white box on the label).



4.2.7 Meter Not Operating

If none of the LEDs light, then check that the correct line voltages are applied to the meter. If the voltages are correct, call customer service for assistance.

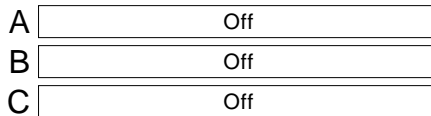

4.2.8 WattNode Error



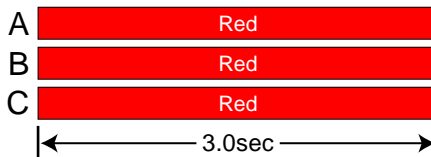



If the meter experiences an internal error, it will light all LEDs red for three or more seconds. If you see this happen repeatedly, call customer service.



For other LED patterns, see the [Operating and Reference Guide](#) or contact support for assistance.

4.3 Communication LED

Near the upper left corner, there is a diagnostic **Com** (communication) LED that can indicate the following:

-  **Green**  **Off** A short green flash indicates a valid packet addressed to this device.
-  **Yellow**  **Off** Short yellow flashes or rapid flashing indicate valid packets addressed to different devices. The BACnet WattNode will only show this indication if it has received no packets addressed to this device for several seconds.
-  **Red** A one second red flash indicates an invalid packet: bad baud rate, bad CRC, noise, bad parity, etc.
-  **R Y R Y R Y** Rapid red/yellow flashing indicates a possible address conflict (two devices with the same DIP switch address).
-  **Yellow** Solid yellow indicates that this meter believes it is the sole master device on the network. It will scan continuously for other devices until another device is found.

4.4 Monitoring

WattNode BACnet models communicate measurements over a BACnet MS/TP network. The measurements include: energy, power, voltage, current, line frequency, power factor, reactive power, and demand.

In order to monitor and configure networked WattNode models, you will need an appropriate monitoring solution, either standalone or PC software.

See the [Operating and Reference Guide](#) for a complete list of network accessible variables.

4.5 Maintenance and Repair

The WattNode meter requires no maintenance. It is not user serviceable and there are no replaceable parts except the pluggable screw terminals. There are no diagnostic tests that can be performed by the user, other than checking for errors via the BACnet interface or the status LEDs.

In the event of any failure, the meter must be returned for service (contact CCS for an RMA). For a new installation, follow the troubleshooting instructions in the [Operating and Reference Guide](#) before returning the meter for service, to ensure that the problem is not connection related.

The WattNode meter should not normally need to be cleaned, but if cleaning is desired, power must be disconnected first and a dry or damp cloth or brush should be used.

5 Specifications

The following is a list of basic specifications. For extended specifications, see the [Operating and Reference Guide](#).

5.1 Accuracy

The following accuracy specifications do not include errors caused by the current transformer accuracy or phase angle errors. "Rated current" is the current that generates a CT output voltage of 0.33333 Vac.

Normal Operation:

- **Line voltage:** -20% to +15% of nominal
- **Power factor:** 1.0
- **Frequency:** 48 - 62 Hz
- **Ambient Temperature:** 23°C ± 5°C
- **CT Current:** 5% - 100% of rated current

Accuracy: ±0.5% of reading

For accuracy at other conditions, see the reference guide.

WattNode Revenue Models:

- Meets the ANSI C12.1-2008 standard for revenue metering when used with IEEE C57.13 class 0.6 current transformers. Includes a certificate of calibration.

5.2 Measurement

Update Rate: 1.0 second. Internally, all measurements are performed at this rate.

Start-Up Time: ~1.3 second. The meter starts communicating this long after AC voltage is applied. Energy measurement starts ~300 milliseconds after AC is applied.

Default CT Phase Angle Correction: 0.0 degrees.

5.3 Electrical

Meter Service Type	Nominal Vac Line-to-Neutral	Nominal Vac Line-to-Line	Phases	Wires
3Y-208	120	208–240	1 or 3	2 - 4
3Y-400	230	400	1 or 3	2 - 4
3Y-480	277	480	1 or 3	2 - 4
3Y-600	347	600	1 or 3	2 - 4
3D-240	120*	208–240	1 or 3	2 - 4
3D-400	230*	400	3	2 - 4
3D-480	277*	480	3	2 - 4

Table 2: WattNode Model Service Types

*Note: the delta models have an optional neutral connection that may be used for measuring wye circuits. In the absence of neutral, voltages are measured with respect to ground. Delta WattNode models use the phase A and phase B connections for power.

Over-Voltage Limit: 125% of nominal Vac. Extended over-voltage operation can damage the WattNode and void the warranty.

Over-Current Limit: 120% of rated current. Exceeding 120% of rated current will not harm the WattNode meter but the current and power will not be measured accurately.

Maximum Surge: 4kV according to EN 61000-4-5, 6kV for WattNode Revenue models.

Power Consumption: The following table shows maximum volt-amperes, the power supply ranges, typical power consumption, and typical power factors with all three phases powered at nominal line voltages. The power supply consumes most of the total power, while the measurement circuitry draws 1-10% of the total (6-96 milliwatts per phase, depending on the model). Due to the design of the power supply, WattNode meters draw slightly more power at 50 Hz.

Meter Service Type	Real Power (60 Hz)	Real Power (50 Hz)	Power Factor	Rated VA ⁽¹⁾	Power Supply Range (Vac)	Power Supply Terminals
3Y-208	1.5 W	1.8 W	0.79	4 VA	96 – 138	N and ΦA
3Y-400	1.6 W	1.8 W	0.73	4 VA	184 – 264	N and ΦA
3Y-480	1.6 W	2.0 W	0.69	4 VA	222 – 318	N and ΦA
3Y-600	1.0 W	1.3 W	0.76	4 VA	278 – 399	N and ΦA
3D-240	1.2 W	1.5 W	0.70	4 VA	166 – 276	ΦA and ΦB
3D-400	1.1 W	1.4 W	0.67	3 VA	320 – 460	ΦA and ΦB
3D-480	1.2 W	1.6 W	0.70	3 VA	384 – 552	ΦA and ΦB

Table 3: Power Consumption and Supply Voltage

⁽¹⁾Note: The **Rated VA** is the maximum at 115% of nominal Vac at 50 Hz. This is the same as the value that appears on the front label of the meter.

Maximum Power Supply Voltage Range: -20% to +15% of nominal (see table above). For the 3D-240 service, this is -20% of 208 Vac (166 Vac) to +15% of 240 Vac (276 Vac).

Operating Frequencies: 50/60 Hz

Measurement Category: CAT III

Measurement category III is for measurements performed in the building installation or on the load side of the main service breaker. Examples are measurements on distribution boards, circuit-breakers, wiring, including cables, bus-bars, junction boxes, switches, socket-outlets in the fixed installation, and equipment for industrial use and some other equipment, for example, stationary motors with permanent connection to the fixed installation.

The line voltage measurement terminals on the meter are rated for the following CAT III voltages (these ratings appear on the front label):

Meter Service Type	CAT III Voltage Rating
3Y-208 3D-240	240 Vac
3Y-400 3D-400	400 Vac
3Y-480 3D-480	480 Vac
3Y-600	600 Vac

Table 4: WattNode CAT III Ratings

Current Transformer Inputs:

Nominal Input Voltage (At CT Rated Current): 0.33333 Vac RMS

Absolute Maximum Input Voltage: 5.0 Vac RMS

Input Impedance at 50/60 Hz: 23 k Ω

5.4 Thermistor Input

The WattNode BACnet is available with **Option TM1**, which provides hardware and firmware updates to support connection of a thermistor between the **C** and **X** pins on the black four-position connector. The firmware for **Option TM1** is not BTL (BACnet Testing Laboratories) certified; however, it is based on BTL certified firmware.

Thermistor Type: 10k, US Sensor J-curve

Temperature Accuracy: $\pm 3^{\circ}\text{C}$, not including thermistor errors

Temperature Resolution: better than 1°C from -50°C to 150°C

Response Time: ≤ 2 seconds (not including thermistor response time)

Temperature Measurement Range: -50°C to 150°C

5.5 EIA RS-485 Interface

RS-485 Output Isolation: 4500 Vac RMS

Driver Output:

- **Voltage (Open Circuit):** ± 6 Vdc maximum
- **Voltage (54 Ω load):** ± 1.5 Vdc minimum
- **Current (54 Ω load):** ± 60 mA typical
- **Rise Time (54 Ω || 50 pF load):** 900 nS typical

Receiver:

- **Common-Mode Range:** -7 Vdc to +12 Vdc max
- **Sensitivity:** ± 200 mV
- **Bus Load:** 1/8 unit load (up to 64 meters)
- **Failsafe Modes:** bus open, shorted, and idle

5.6 Certifications

Safety:

- UL 61010-1 (3rd Edition)
- CAN/CSA-C22.2 No. 61010-1-04
- IEC 61010-1:2010 (3rd Edition)

Immunity: EN 61326: 2002 (Industrial Locations)

Electrostatic Discharge: EN 61000-4-2

Radiated RF Immunity: EN 61000-4-3

Electrical Fast Transient / Burst: EN 61000-4-4

Surge Immunity: EN 61000-4-5

Conducted RF Immunity: EN 61000-4-6

Voltage Dips, Interrupts: EN 61000-4-11

Emissions:

- FCC Part 15, Class B
- EN 55022: 1994, Class B

5.7 Environmental

Operating Temperature: -40°C to +75°C (-40°F to 167°F)

Altitude: Up to 2000 m (6560 ft)

Operating Humidity: non-condensing, 5 to 90% relative humidity (RH) up to 40°C, decreasing linearly to 50% RH at 55°C.

Pollution: POLLUTION DEGREE 2 - Normally only non-conductive pollution; occasionally, a temporary conductivity caused by condensation must be expected.

Indoor Use: Suitable for indoor use.

Outdoor Use: Suitable for outdoor use if mounted inside an electrical enclosure (Hammond Mfg., Type EJ Series) rated NEMA 3R or 4 (IP 66).

5.8 Mechanical

Enclosure: High impact, ABS/PC plastic

Flame Resistance Rating: UL 94V-0, IEC FV-0

Size: 6.02 in. x 3.35 in. x 1.50 in. (153 mm x 85 mm x 38 mm)

Connectors: Euroblock pluggable terminal blocks

Green: up to 12 AWG (2.5 mm²), 600 V

Black: up to 12 AWG (2.5 mm²), 300 V

5.9 FCC Information

This equipment has been tested and complies with the limits for a Class B digital device, pursuant to part 15 of the FCC Rules. Operation is subject to the following two conditions: (1) This device may not cause harmful interference, and (2) this device must accept any interference received, including interference that may cause undesired operation.

The FCC limits are designed to provide reasonable protection against harmful interference in a residential installation. This equipment generates, uses and can radiate radio frequency energy and, if not installed and used in accordance with the instructions, may cause harmful interference to radio communications. However, there is no guarantee that interference will not occur in a particular installation. If this equipment does cause harmful interference to radio or television reception, which can be determined by turning the equipment off and on, the user is encouraged to try to correct the interference by one or more of the following measures:

- Reorient or relocate the receiving antenna.
- Increase the separation between the equipment and receiver.
- Connect the equipment to a circuit different from that to which the receiver is connected.
- Consult the dealer or an experienced radio/TV technician for help.

5.10 Warranty

All products sold by Continental Control Systems, LLC (CCS) are guaranteed against defects in material and workmanship for a period of five years from the original date of shipment. CCS's responsibility is limited to repair, replacement, or refund, any of which may be selected by CCS at its sole discretion. CCS reserves the right to substitute functionally equivalent new or serviceable used parts.

This warranty covers only defects arising under normal use and does not include malfunctions or failures resulting from: misuse, neglect, improper application, improper installation, water damage, acts of nature, lightning, product modifications, alterations or repairs by anyone other than CCS.

Except as set forth herein, CCS makes no warranties, expressed or implied, and CCS disclaims and negates all other warranties, including without limitation, implied warranties of merchantability and fitness for a particular purpose.

5.11 Limitation of Liability

In no event shall CCS be liable for any indirect, special, incidental, punitive or consequential damages of any kind or nature arising out of the sale or use of its products whether such liability is asserted on the basis of contract, tort or otherwise, including without limitation, lost profits, even if CCS has been advised of the possibility of such damages.

Customer acknowledges that CCS's aggregate liability to Customer relating to or arising out of the sale or use of CCS's products, whether such liability is asserted on the basis of contract, tort or otherwise, shall not exceed the purchase price paid by Customer for the products in respect of which damages are claimed. Customer specifically acknowledges that CCS's price for the products is based upon the limitations of CCS's liability set forth herein.

©2009-2017 Continental Control Systems, LLC.

Document Number: WN-Inst-BN-2.20

Revision Date: August 16, 2017

Continental Control Systems, LLC

1(303) 444-7422, <https://www.ctlsys.com>

- WattNode is a registered trademark of Continental Control Systems, LLC.
- BACnet is a registered trademark of American Society of Heating, Refrigerating and Air-Conditioning Engineers (ASHRAE)

(M8)

Rev 2.20