

WATTNODE[®] METER MODULE

for MODBUS[®]

Electric Power Meter - Installation Manual



WattNode Meter Module Models

WND-M1-MB



www.ctlsys.com

Contents

1	Precautions	3
1.8	Symbols	3
2	Overview	4
2.1	Additional Literature	4
2.2	Electrical Service Types	4
3	Installation	6
3.1	Installation Checklist	6
3.2	Mounting	6
3.3	Connect Voltage Terminals	6
3.4	Connect Current Transformers	7
3.5	RS-485 Communication Connection	8
3.6	Power Supply Connection	9
4	Operation	10
4.1	Initial Configuration	10
4.2	Phase Status LEDs	10
4.3	Modbus Communication LED	11
4.4	Monitoring	11
4.5	Maintenance and Repair	12
5	Specifications	13
5.1	Accuracy	13
5.2	Measurement	13
5.3	Electrical	13
5.4	EIA RS-485 Interface	14
5.5	Certifications	14
5.6	Environmental	15
5.7	Mechanical	15
5.8	FCC Information	16
5.9	Warranty	16
5.10	Limitation of Liability	16

1 Precautions

- 1.1 Only qualified personnel or **licensed electricians** should install the WattNode Meter Module. The mains voltages of 120 to 600 Vac can be lethal!
- 1.2 Follow all applicable local and national electrical and safety codes.
- 1.3 The terminal block screws are **not** insulated. Do not contact metal tools to the screw terminals if the circuit is live!
- 1.4 Verify that circuit voltages and currents are within the proper range for the meter model.
- 1.5 Use only UL Listed or UL Recognized current transformers (CTs). Depending on the meter options, you may use either CTs with built-in burden resistors that generate 0.333 Vac (333 millivolts AC) at rated current or milliamp output CTs that generate up to 100 mA at rated current. **Do not use 1 amp or 5 amp output CTs: they will destroy the meter and may create a shock hazard.**
- 1.6 Disconnect equipment from HAZARDOUS LIVE voltages before access.
- 1.7 If the meter is not installed correctly, the safety protections may be impaired.

1.8 Symbols



Read, understand, and follow all instructions including warnings and precautions before installing and using the product.



Potential Shock Hazard from Dangerous High Voltage.



Functional ground; should be connected to earth ground if possible, but is not required for safety grounding.



UL Listing mark for U.S.A. and Canada.



UL Recognized mark.



FCC Mark. This logo indicates compliance with part 15 of the FCC rules.



Complies with the regulations of the European Union for Product Safety and Electro-Magnetic Compatibility.

- Low Voltage Directive – EN 61010-1:2010 (3rd Edition)
 - EMC Directive – EN 61326-1:2013
-



This indicates an AC voltage.

2 Overview

Congratulations on your purchase of the WattNode® Meter Module for Modbus® watt/watt-hour meter. The Meter Module enables you to make power and energy measurements within electric service panels avoiding the costly installation of subpanels and associated wiring. It is designed for use in demand side management (DSM), submetering, energy monitoring, billing and renewable energy applications. The Meter Module communicates on an EIA RS-485 two-wire bus using the Modbus RTU protocol.

The Meter Module meets the ANSI C12.1 Class 1 standard for revenue metering when used with class 0.5 or class 0.6 current transformers. It meets the ANSI C12.20 Class 0.5 standard for revenue metering when used with class 0.2 or class 0.3 current transformers.

2.1 Additional Literature

See the Continental Control Systems, LLC website (ctlsys.com) for product pages, datasheets, and support pages for all WattNode meter models and current transformers. Each WattNode model has an [Operating and Reference Guide](#) with detailed information on the available measurements and interface.

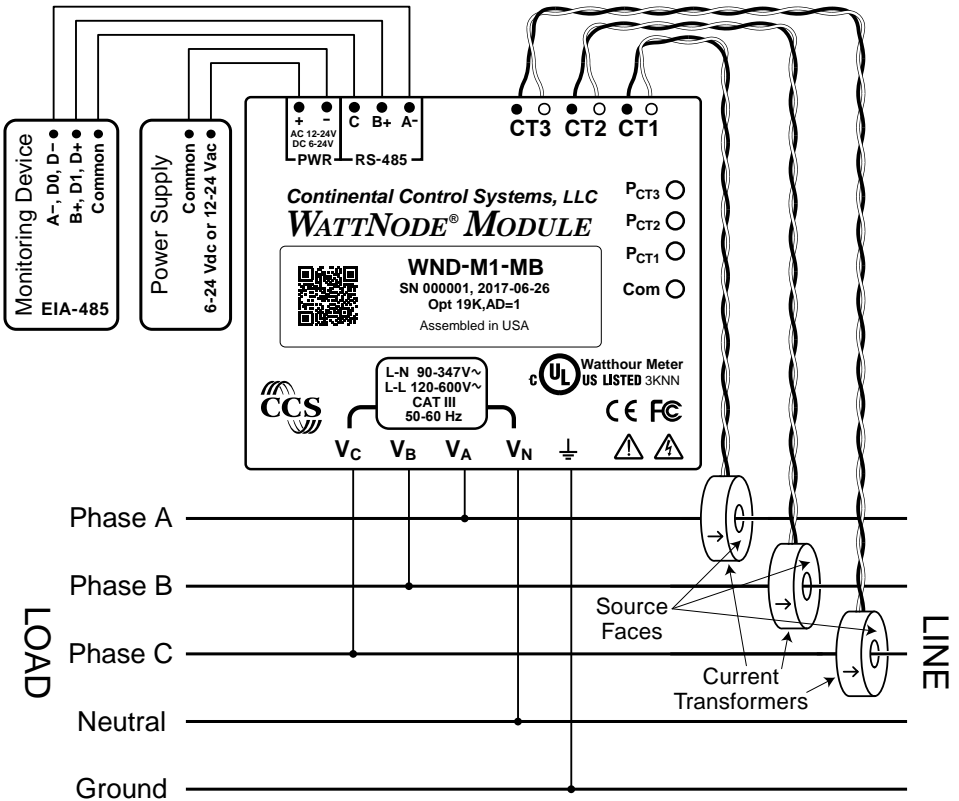

Figure 1: Wiring Diagram

2.2 Electrical Service Types

The WND-M1-MB Meter Module supports any electrical service from 90 to 600 Vac, line-to-neutral or line-to-line, 50 to 60 Hz, single-phase, split-phase, or three-phase, wye or delta.

Connect the line voltages to the meter inputs as shown in the following figures for each service type. See **Figure 1** above for an overview.

2.2.1 Single-Phase Two-Wire with Neutral

This is a common residential and branch circuit connection. You may monitor up to three single-phase circuits with one meter by also using the V_B and V_C inputs.

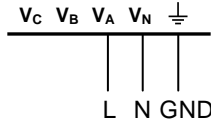

2.2.2 Single-Phase Two-Wire No Neutral

This circuit occurs in residential (commonly 120/240 Vac) and some commercial applications.

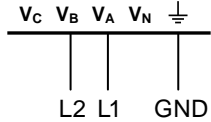

2.2.3 Single-Phase Three-Wire with Neutral

This is a common North American residential service at 120/240 Vac.

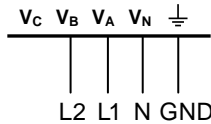

2.2.4 Three-Phase Three-Wire Delta (No Neutral)

This is common in commercial and industrial settings. In some cases, the service may be four-wire wye while the load is three wire (no neutral).

Occasionally, a load will only be connected to two of the three lines (say $L1$ and $L2$). For this case, connect the two active lines to the V_A and V_B terminals and connect one CT for the two lines.

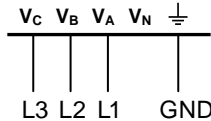

2.2.5 Three-Phase Four-Wire Wye with Neutral

This is a common commercial and industrial service.

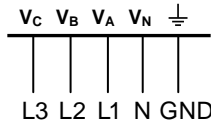

2.2.6 Grounded Leg Service

In rare cases with delta services or single-phase two-wire services without neutral, one of the phases may be grounded.

The meter will correctly measure services with a grounded leg, but the measured voltage and power for the grounded phase will be zero. The status LEDs will not light for the grounded phase because the voltage is near zero. This type of service may result in unusual power factors.

See the web article [Grounded Leg Services](#) for more information.

3 Installation

3.1 Installation Checklist

See the sections referenced below for installation details.

- **Turn off power** before making line voltage connections.
- Mount the meter (see **3.2**).
- Connect the line voltage wires to the meter's green terminal block (see **3.3.2**).
- Mount the CTs around the line conductors. Make sure the CTs face the **source** (see **3.4**).
- Connect the twisted white and black wires from the CTs to the black terminal block on the meter, matching the wire colors to the white and black dots on the meter label (see **3.4.3**).
- Check that the CT phases match the line voltage phases (see **3.4**).
- Record the CT rated current for each CT. They will be required during commissioning.
- Connect the output terminals of the meter to the monitoring equipment (see **3.5**).
- Connect the meter power supply terminals to the external power supply: 6-24 Vdc or 12-24 Vac (see **3.6**).
- Check that all the wires are securely installed in the terminal blocks by tugging on each wire.
- Turn on the line voltage connection to the meter.
- Turn on the meter power supply.
- Verify that the LEDs indicate correct operation (see **4.2, 4.3**).

3.2 Mounting

- Protect the meter from temperatures below -40°C (-40°F) or above 80°C (176°F), excessive moisture, dust, salt spray, or other contamination, using a NEMA rated enclosure if necessary. The meter requires an environment no worse than pollution degree 2 (normally only non-conductive pollution; occasionally, a temporary conductivity caused by condensation).
- The meter must be installed in an electrical service panel or an enclosure.
- The meter module is designed for DIN rail mounting on an EN 50022, 35 mm, top hat section rail, also called type O, type Ω , or TS35. It is compatible with both the normal 7.5 mm depth and the 15 mm deep style rails.

The meter module has a DIN rail release tab in the lower-right corner. Pull this tab down with your finger or a flat-bladed screwdriver to release the meter from the DIN rail.

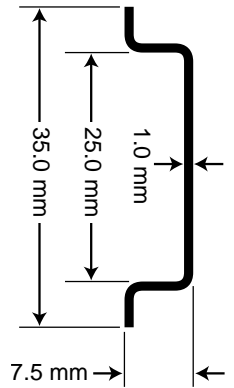

DIN Rail Dimensions

3.3 Connect Voltage Terminals

3.3.1 Circuit Protection

The Meter Module meets the UL and IEC 61010-1 requirements for overcurrent protection with its impedance limited mains circuitry, so external fuses or circuit breakers are not required for over-current protection. However, the Meter Module is considered “permanently connected equipment” and **requires a disconnect means: switch, disconnect, or circuit breaker.**

The meter line voltage inputs only draw microamps of current to sense the voltage, so the rating of any switches, disconnects, or circuit breakers is determined by the wire gauge, the mains voltage, and the current interrupting rating required.

- The disconnect or circuit breaker must be clearly marked, suitably located, and easily reached.
- Use ganged circuit breakers when monitoring more than one line voltage.
- The circuit disconnect system must meet IEC 60947-1 and IEC 60947-3, as well as all national and local electrical codes.

3.3.2 Line Wiring

- **Always turn off the line voltage source** before connecting the line voltages to the meter.
- For the line voltage wires, CCS recommends 18 to 12 AWG stranded wire, type THHN, MTW, or THWN, 600 V.
- **Use copper conductors only.** The screw terminals are only rated for copper wire.
- Do not place more than one wire in a screw terminal; use wire nuts or terminal blocks if needed.

Connect each line voltage to the appropriate phase as shown in sections 2.2.1 to 2.2.5 above and connect ground and neutral if applicable.

The screw terminals handle wire up to 12 AWG. Connect each voltage line to the green terminal block as shown in **Figure 1** above. After connecting the voltage wires, make sure both terminal blocks are fully seated in the meter.

3.3.3 Grounding

The WattNode Meter Module uses a plastic enclosure, insulation, and internal isolation barriers instead of protective earthing. The ground terminal on the green screw terminal block is a functional ground, designed to improve the measurement accuracy and noise immunity. If necessary, this terminal may be left disconnected.

3.4 Connect Current Transformers

To meet the UL listing requirements, the meter must be used with UL Listed or the following UL Recognized current transformer models. Depending on the meter options, it can support CTs with a 333.33 mVac output or CTs with a milliamp output (up to 100 mA). See the current transformer datasheets for CT ratings.

3.4.1 Approved UL Recognized Current Transformers

ACT-0750-xxx	CTS-2000-xxxx	CTT-0750-xxx
CTL-1250-xxx	CTB-WxL-xxxx	CTT-1000-xxx
CTM-0360-xxx	CTBL-WxL-xxxx	CTT-1250-xxx
CTS-0750-xxx	CTT-0300-xxx	CTRC-yyyyy-xxxx
CTS-1250-xxx	CTT-0500-xxx	

- “xxx” indicates the full scale current rating.
- “WxL” indicates the opening width (W) and leg length (L) in inches.
- “dddd” indicates the opening diameter of the loop for flexible Rogowski CTs.
- “yyyyy” indicates the opening size in mils (thousandths of inches).

In addition to the CTs listed above, any UL Listed CT with a 333.33 mVac output may be used with the meter.

The meter must be factory configured to use milliamp output CTs: contact CCS for details.

3.4.2 Current Transformer Installation

See the web article [Selecting Current Transformers](#) for information on selecting appropriate current transformers (CTs).

- **WARNING:** To reduce the risk of electric shock, always open or disconnect circuit from power-distribution system or service of the building before installing or servicing current transformers.
- **Do not** use 1 amp or 5 amp current output CTs!
- The CTs are not suitable for Class 2 wiring methods and must be treated as Class 1 wires.
- Secure each current transformer and route the lead wires so that they do not directly contact live terminals or bus.
- Do not install current transformers where they would: 1) exceed 75 percent of the wiring space of any cross-sectional area within the equipment, 2) would block ventilation openings, or 3) would be in an area of breaker arc venting.
- See the CT datasheets for the maximum input current ratings.

- To minimize current measurement noise, avoid extending the CT wires beyond 50 feet (15 meters), especially in noisy environments. If it is necessary to extend the wires, use twisted pair wire 22 to 14 AWG, rated for 300 V or 600 V (not less than the service voltage) and shielded if possible.
- Find the source arrow or label “THIS SIDE TOWARD SOURCE” on the CT and face/point toward the source of current.

Install the CTs around the conductor to be measured and connect the CT leads to the meter. Put the line conductors through the CTs as shown in **Figure 1** above.

CTs are directional. If they are mounted backward or with their white and black wires swapped the measured power will be negative. The status LEDs **P_{CT1}**, **P_{CT2}**, and **P_{CT3}** indicate negative measured power by flashing red.

Split-core CTs can be opened for installation around a conductor. A nylon cable tie may be secured around the CT to prevent inadvertent opening.

For revenue accuracy, use accuracy class 0.3 or 0.2 current transformers to achieve a 0.5% system accuracy or class 0.5 or 0.6 CTs for a 1.0% system accuracy; other CTs are less accurate and may not provide revenue accuracy. Contact sales for more information on appropriate CTs.

3.4.3 CT Wiring

The current transformers connect to the six-position black screw terminal block. Connect the white and black CT wires to the meter terminals marked **CT1**, **CT2**, and **CT3** (see **Figure 1** above). Excess length may be trimmed from the wires if desired. Connect each CT with the white wire aligned with the white dot on the label, and the black wire aligned with the black dot. Note the order in which the phases are connected, as the line voltage phases **must** match the current phases for accurate power measurement.

3.5 RS-485 Communication Connection

- The meter outputs are electrically isolated from dangerous voltages.
- If the output wiring is near line voltage wiring, use wires or cables with a 300 V or 600 V rating (not less than the service voltage).
- If the output wiring is near bare conductors, it should be double insulated or jacketed.
- You may install two wires into each screw terminal by twisting the wires together, inserting them into the terminal, and securely tightening. Note: a loose wire can disable an entire network section.
- Use a shielded twisted-pair cable to prevent interference. If there is no common conductor, connect the shield to the **C** terminal.

3.5.1 Modbus RTU

You can connect the WattNode Meter Module to PCs with RS-485 interfaces, gateways, data loggers, and other devices that accept RS-485 Modbus RTU.

The Modbus address defaults to 1 unless the meter is ordered with **Opt AD=xxx**, where **xxx** may be any address from 1 to 247. **If you are connecting multiple meters on the same network, you may want to pre-configure the Modbus addresses so that they do not conflict.**

The baud rate defaults to 19200 unless the meter is ordered with **Opt BAUD=yyy**, where **yyy** may be one of the following: 1200, 2400, 4800, 9600, 19200, 38400, 57600, or 76800, 115200.

If the meter was ordered with address or baud rate options, they will appear on the label.

The rest of the RS-485 settings default to no parity, 8 data bits, and 1 stop bit (N81).

The communication settings may also be changed using the Modbus registers **BaudRate**, **Address**, **ParityMode**, **ModbusMode**, **SerialNumberKey**, and **NewAddress**. See the [Operating and Reference Guide](#) for details.

3.5.2 Connect RS-485

- RS-485 wiring can be complex when multiple devices are connected, when running wires for long distances, and when using termination and bias resistors. If you have any questions, consult the [Operating and Reference Guide](#).
- Be sure to connect the **A-**, **B+**, and **C** (common) terminals. You may use the cable shield (if present) for the **C** connection.
- For long distances, use a shielded twisted-pair cable to prevent interference. With a shielded cable, connect the shield to earth ground at one end.
- You may daisy-chain RS-485 wiring between meters, with up to 64 devices per subnet.

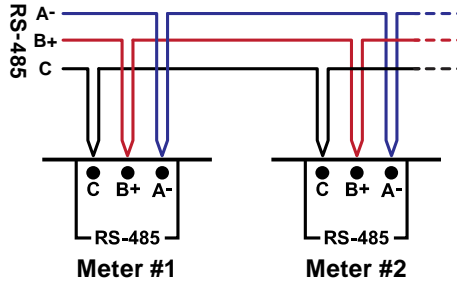

3.6 Power Supply Connection

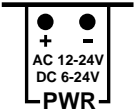

The WattNode Meter Module is powered by 6-24 Vdc or 12-24 Vac. The meter typically draws 50 milliamps at 12 Vdc and less than 150 milliamps maximum (see **5.3 Electrical** for details). To meet the UL listing requirements, the meter must be used with one of the following power sources:

- UL Listed, Class 2 transformer: 12 - 24 Vac secondary, rated minimum of 5 VA
- 6 to 24 Vdc power supply, 3 W minimum, UL 60950 Listed, external brick type
- 12 to 24 Vac power supply, 3 W minimum, UL 60950 Listed, external brick type
- The Mean Well MDR-10-12. The MDR-10-12 is rated for 10 watts output, 12 Vdc output, 85 to 264 Vac input, -20°C to 70°C (-4°F to 158°F) operation. When using the MDR-10-12 it must be located in the electrical enclosure with the Meter Module.

Warning: be sure the temperature rating of the transformer or power supply is not exceeded in the installation! Not all transformers or supplies support the -40°C to 80°C (-40°F to 176°F) range of the Meter Module.

The Meter Module has no power LED, but when power is applied, the meter will light all the LEDs in a startup sequence of red, yellow, then green (see **4.2.1 Normal Startup**). After startup, the phase LEDs will always display some pattern so long as the meter is operating correctly.

3.6.1 DC Power Supply

For DC power (6-24 Vdc), connect the common or negative to the ‘-’ terminal and the positive connection to the ‘+’ terminal. The PWR terminals and RS-485 terminals are **not internally isolated from each other**. You may use a DC supply with the same ground as the RS-485 common (effectively shorting the PWR ‘-’ terminal to the RS-485 ‘C’ terminal) or use a DC supply that has a floating or isolated output.

3.6.2 AC Power Supply

For AC power (12-24 Vac), connect AC supply to the ‘-’ and ‘+’ terminals; the polarity does not matter. The AC source must be floating or isolated from the RS-485 common for correct operation.

4 Operation

4.1 Initial Configuration

Generally, the network integrator will remotely configure the WattNode Meter Module and the variables. For details on configuring the meter, see the appropriate [Operating and Reference Guide](#) for your model.

The meter does not include a display or buttons, so it is not possible to configure or monitor the meter directly, other than the basic LED diagnostics described below.

At a minimum, you must program the **CtAmps** with the rated amps of the attached current transformers for correct measurements.

4.2 Phase Status LEDs

The three status LEDs on the front of the meter can help indicate correct measurements and operation. **P_{CT1}**, **P_{CT2}**, and **P_{CT3}** on the diagrams below correspond to the phase status LEDs.

4.2.1 Normal Startup

The meter displays the following startup sequence whenever power is first applied.

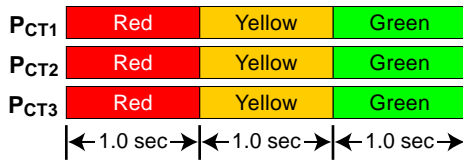

4.2.2 Positive Power

Any phase with the LEDs flashing green is indicating normal positive power.

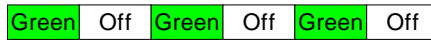

4.2.3 No Power

Any phase with a solid green LED indicates no active power, but line voltage is present.



4.2.4 No Voltage

Any LED that is off indicates no voltage on that phase. No voltage is defined as a voltage less than 20% of the meter's nominal voltage or 20% of the highest measured voltage on any phase, whichever is higher.

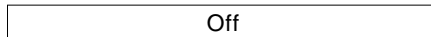

4.2.5 No Voltage on Any Phase

If the meter measures no voltage (see 4.2.4 above) on all three voltage inputs, then the meter will display the following pattern to show that it has DC power, but no AC voltages.

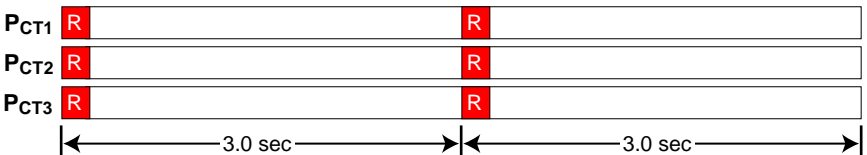

4.2.6 Negative Power

Red flashing indicates negative power for that phase. Reversed CTs, swapped CT wires, or CTs not matched with line voltage phases can cause this.



4.2.7 Overvoltage Warning

The following warning pattern indicates that the line voltage is too high (above 720 Vac) for the meter. Check the line voltages and the meter ratings (in the white box on the label).

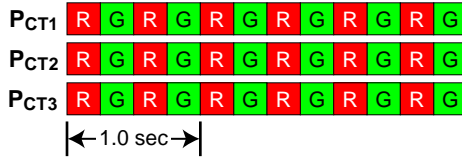

4.2.8 Meter Not Operating

If none of the LEDs light, then check that the power supply is connected to the meter and operating. You may also want to check the supply voltage with a multimeter. If the supply voltages are correct, call customer service for assistance.

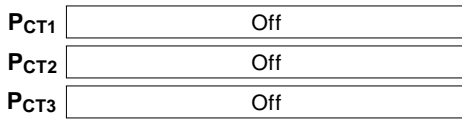

4.2.9 WattNode Error

If the meter experiences an internal error, it will light all LEDs red for three or more seconds. If you see this happen repeatedly, return the meter for service.

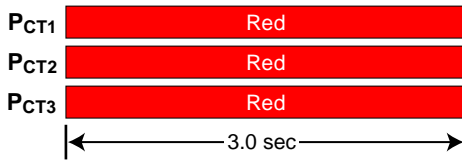

For other LED patterns, see the [Operating and Reference Guide](#) or contact support.

4.3 Modbus Communication LED

There is a diagnostic **Comm** (communication) LED that can indicate the following:

- Off A short green flash indicates a valid packet addressed to this device.
- Off Short yellow flashes or rapid flashing indicate valid packets addressed to different devices.
- A one-second red flash indicates an invalid packet: incorrect baud rate, bad CRC, noise, bad parity, etc.
- Rapid red/yellow flashing indicates a possible address conflict (two devices with the same DIP switch address).
- Solid red indicates the address is set to zero: an invalid choice.

4.4 Monitoring

Modbus meter models communicate measurements over a Modbus RTU network. The measurements include: energy, power, voltage, current, line frequency, power factor, reactive power, and demand.

To monitor and configure networked meters, you will need an appropriate monitoring solution, either standalone or PC software.

See the [Operating and Reference Guide](#) for a complete list of the Modbus registers (variables).

4.5 Maintenance and Repair

The WattNode Meter Module requires no maintenance. It is not user serviceable, and there are no replaceable parts except the pluggable screw terminals. There are no diagnostic tests that can be performed by the user, other than checking for errors via the Modbus interface or the status LEDs.

In the event of any failure, the meter must be returned for service (contact CCS for an RMA). For a new installation, follow the troubleshooting instructions in the [Operating and Reference Guide](#) before returning the meter for service, to ensure that the problem is not connection related.

If desired, to clean the meter, disconnect power and then use a dry or damp cloth or a brush.

5 Specifications

The following is a list of basic specifications. For extended specifications, see the [Operating and Reference Guide](#).

5.1 Accuracy

The following accuracy specifications do not include errors caused by the current transformer accuracy or phase angle errors. "Rated current" is the current that generates a CT output voltage of 0.33333 Vac or equivalent milliamp output.

Normal Operation:

- **Line voltage:** 100 to 690 Vac
- **Power factor:** 1.0
- **Frequency:** 48 - 62 Hz
- **Ambient Temperature:** 23°C ± 5°C
- **CT Current:** 1% - 100% of rated current

Accuracy: ±0.5% of reading

For accuracy at other conditions, see the reference guide.

Revenue Models:

- Meets the ANSI C12.1-2008 standard for revenue metering when used with class 0.6 or better current transformers.
- Meets the ANSI C12.20-2010 standard for revenue metering when used with class 0.3 or better current transformers.

5.2 Measurement

Update Rate: 0.1 second. Internally, all measurements are performed at this rate, except the energy registers, which are updated every 1.0 second.

Start-Up Time: Energy measurement starts ~100 milliseconds after the supply voltage is applied. Modbus communication is enabled ~300 milliseconds after the supply is applied; at this time, all the registers will report valid data, such as power, voltage, current, etc.

Default CT Phase Angle Correction: 0.0 degrees.

5.3 Electrical

Power Supply

Nominal Power Supply Voltage: 6 to 24 Vdc or 12 to 24 Vac

Power Supply Minimum Operating Voltage: 6 Vdc or 10 Vac

Power Supply Absolute Maximum Voltage: 40 Vdc or 30 Vac

Power Supply Watts: typical 0.6 W, maximum 1.0 W

Power Supply Current (milliamps):

DC Supply Volts	Typical (mA)	Maximum (mA)
6	90	130
12	50	70
18	35	50
24	30	45
30	27	40

Line Frequency: 45 to 65 Hz

Nominal Line-to-Neutral Vac: 90 to 347 Vac

Nominal Line-to-Line Vac: 120 to 600 Vac

Measurement Over-Voltage Limit: 720 Vac

Over-Current Limit: 200% of rated current. Exceeding 200% of rated current will not harm the meter, but the current and power will not be measured accurately.

Maximum Surge: EN 61000-4-5: 2 kV, ANSI C12.1 combination wave: 6 kV, 1.2/50 μ s – 8/20 μ s

Line Voltage Power Consumption: The line voltage sensing circuitry draws 0.006 watts per phase at 120 Vac, increasing to 0.150 watts per phase at 600 Vac.

Real Power (50-60 Hz): \leq 0.2 watts

Power Factor: \sim 1.0

Rated VA: 0.25 VA at 720 Vac, 50 Hz. The **Rated VA** is the maximum at 115% of nominal Vac at 50 Hz.

Measurement Category: The line voltage measurement terminals on the meter are rated for CAT III, 600 Vac

Measurement Category III is for measurements performed in the building installation. Examples are measurements on distribution boards, circuit-breakers, wiring, including cables, busbars, junction boxes, switches, socket-outlets in the fixed installation, and equipment for industrial use and some other equipment, for example, stationary motors with a permanent connection to the fixed installation.

Current Transformer Inputs:

Voltage Mode:

Nominal Input Voltage (At CT Rated Current): 0.33333 Vac RMS

Absolute Maximum Input Voltage: 5.0 Vac RMS

Input Impedance at 50/60 Hz: 23 k Ω

Current Mode:

Nominal Input Current (At CT Rated Current): 40 mA RMS

Absolute Maximum Input Current: 200 mA RMS

Input Impedance at 50/60 Hz: 10 Ω

5.4 EIA RS-485 Interface

RS-485 Output Isolation: 4500 Vac RMS

Driver Output:

Voltage (Open Circuit): \pm 6 Vdc maximum

Voltage (54 Ω load): \pm 1.5 Vdc minimum

Current (54 Ω load): \pm 60 mA typical

Rise Time (54 Ω || 50 pF load): 900 nS typical

Receiver:

Common-Mode Range: -7 Vdc to +12 Vdc max

Sensitivity: \pm 200 mV

Bus Load: 1/8 unit load (up to 64 meters)

Failsafe Modes: bus open, shorted, and idle

5.5 Certifications

Safety:

UL: Listed UL 61010-1, 3rd Edition

CAN/CSA-C22.2 No.: 61010-1-12, 3rd Edition

IEC: 61010-1:2010 (3rd Edition)

FCC: Class B, FCC Part 15, radiated and conducted emissions

CE: EN 61326-1: 2013, industrial locations

Radiated Emissions: CISPR / EN 55011, Class B

Conducted Emissions: CISPR / EN 55011, Class B

Electrostatic Discharge: EN/IEC 61000-4-2: (B) Self-Recovering

Radiated RF Immunity: EN/IEC 61000-4-3: (A) No Degradation

Electrical Fast Transient / Burst: EN/IEC 61000-4-4: (A) No Degradation

Surge Immunity: EN/IEC 61000-4-5: (A) No Degradation

Conducted RF Immunity: EN/IEC 61000-4-6: (A) No Degradation
Power Frequency H-field Immunity: EN/IEC 61000-4-8: (A) No Degradation
Voltage Dips, Interrupts: EN/IEC 61000-4-11: (B) Self-Recovering

RoHS Compliant

5.6 Environmental

Operating Temperature: -40°C to +80°C (-40°F to 176°F)

Altitude: Up to 3000 m (9842 ft)

Operating Humidity: non-condensing, 5 to 90% relative humidity (RH) up to 40°C, decreasing linearly to 50% RH at 55°C.

Pollution: POLLUTION DEGREE 2 - Normally only non-conductive pollution; occasionally, a temporary conductivity caused by condensation must be expected.

Indoor Use: Suitable for indoor use.

Outdoor Use: Suitable for outdoor use if mounted inside an electrical enclosure (Hammond Mfg., Type EJ Series) rated NEMA 3R or 4 (IP 66).

5.7 Mechanical

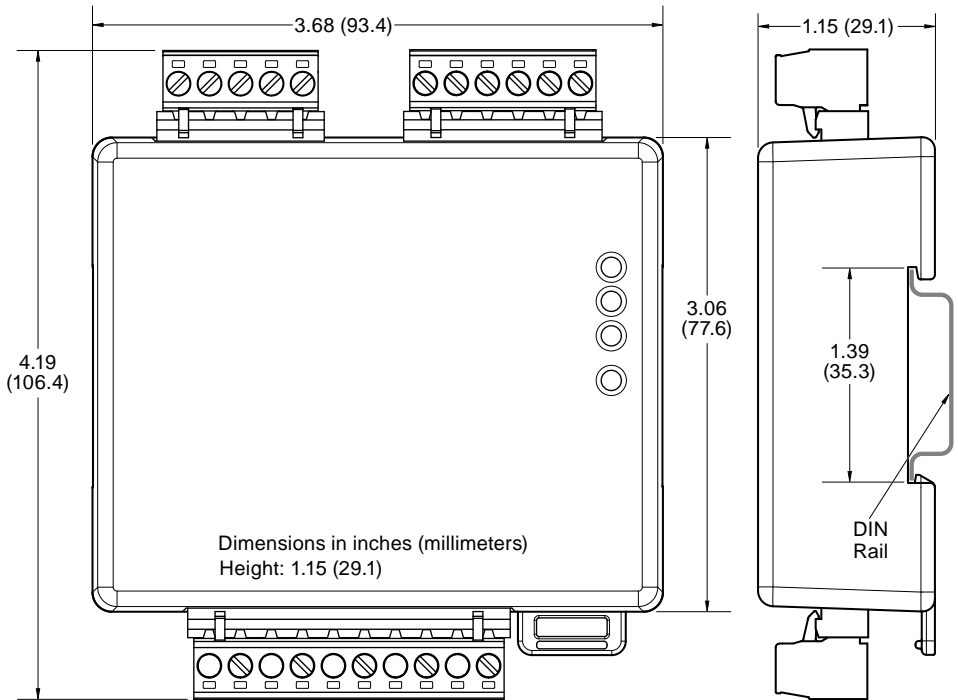

Enclosure: High impact, ABS/PC plastic

Flame Resistance Rating: UL 94V-0, IEC FV-0

Size: 4.19 in. x 3.68 in. x 1.15 in. (106.4 mm x 93.4 mm x 29.1 mm)

DIN Rail: EN 50022, 35 mm, top hat section rail, also called type O, type Ω, or TS35. Compatible with 7.5 mm depth and 15 mm depth rails

Connectors: Euroblock pluggable terminal blocks

Green: up to 12 AWG (2.5 mm²), 600 V

Black: up to 12 AWG (2.5 mm²), 300 V

Weight: 134 gm (4.7 oz)

5.8 FCC Information

This equipment has been tested and complies with the limits for a Class B digital device, pursuant to part 15 of the FCC Rules. Operation is subject to the following two conditions: (1) This device may not cause harmful interference, and (2) this device must accept any interference received, including interference that may cause undesired operation.

The FCC limits are designed to provide reasonable protection against harmful interference in a residential installation. This equipment generates, uses and can radiate radio frequency energy and, if not installed and used in accordance with the instructions, may cause harmful interference to radio communications. However, there is no guarantee that interference will not occur in a particular installation. If this equipment does cause harmful interference to radio or television reception, which can be determined by turning the equipment off and on, the user is encouraged to try to correct the interference by one or more of the following measures:

- Reorient or relocate the receiving antenna.
- Increase the separation between the equipment and receiver.
- Connect the equipment to a circuit different from that to which the receiver is connected.
- Consult the dealer or an experienced radio/TV technician for help.

5.9 Warranty

All products sold by Continental Control Systems, LLC (CCS) are guaranteed against defects in material and workmanship for a period of five years from the original date of shipment. CCS's responsibility is limited to repair, replacement, or refund, any of which may be selected by CCS at its sole discretion. CCS reserves the right to substitute functionally equivalent new or serviceable used parts.

This warranty covers only defects arising under normal use and does not include malfunctions or failures resulting from: misuse, neglect, improper application, improper installation, water damage, acts of nature, lightning, product modifications, alterations or repairs by anyone other than CCS.

Except as set forth herein, CCS makes no warranties, expressed or implied, and CCS disclaims and negates all other warranties, including without limitation, implied warranties of merchantability and fitness for a particular purpose.

5.10 Limitation of Liability

In no event shall CCS be liable for any indirect, special, incidental, punitive or consequential damages of any kind or nature arising out of the sale or use of its products whether such liability is asserted on the basis of contract, tort or otherwise, including without limitation, lost profits, even if CCS has been advised of the possibility of such damages.

Customer acknowledges that CCS's aggregate liability to Customer relating to or arising out of the sale or use of CCS's products, whether such liability is asserted on the basis of contract, tort or otherwise, shall not exceed the purchase price paid by Customer for the products in respect of which damages are claimed. Customer specifically acknowledges that CCS's price for the products is based upon the limitations of CCS's liability set forth herein.

©2009-2017 Continental Control Systems, LLC.
Document Number: WND-Inst-M1-MB Rev 1.10
Revision Date: December 22, 2017

Continental Control Systems, LLC
+1(303) 444-7422, <https://ctlsys.com>

- WattNode is a registered trademark of Continental Control Systems, LLC.
- Modbus is a registered trademark of Schneider Electric USA, Inc.